

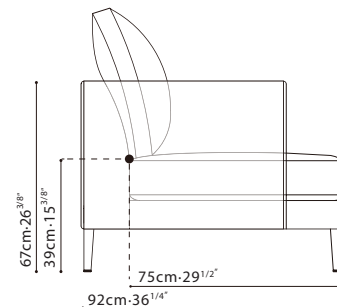

NOTTING / FRAME: Constructed in solid birch wood frame, paired with cross-woven elastic webbing. Frame is covered with polyurethane foam and fabric lining. CUSHIONS: Seat cushions consist of high-resilient polyurethane foam, topped with compartmented feather down and polyester fiber. Back cushions consists of channeled feather down and polyester fiber padding with high-resilient polyurethane foam center insert. Throw cushion, C08TYK01, is filled with feather down. All cushions have hidden zipper closing. LEGS: Steel legs are finished in black metallic paint and capped with plastic glides. UPHOLSTERY: Fabric (removable via Velcro) or Leather (non-removable) . Sofa Connectors are Included.



FABRIC VERSION

C01D0101

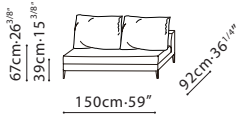

C01D0102

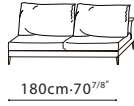

C01D0103

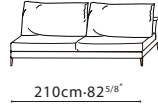

C01D0104



C01D0105

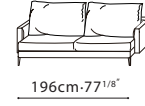

C01D0106



C01D0107

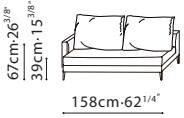

C01D0108



C01D0109

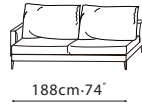

C01D0110

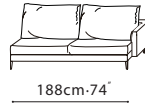

C01D0111

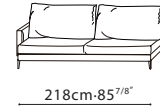

C01D0112

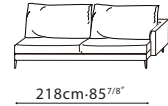

C01D0113

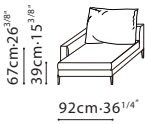

C01D0114



C01D0115



C01D0116



C01D0117



C08TYK01

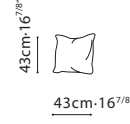

B12D0118

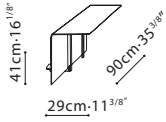

Optional Side Table can be attached to the following LAF/RAF Sofa Arm/Armless pieces: C01D0101/02/03/07/08/09/10/11/12. Constructed on a Blackened Steel Frame, upholstered in FC-03 Taupe Eco-Leather.