

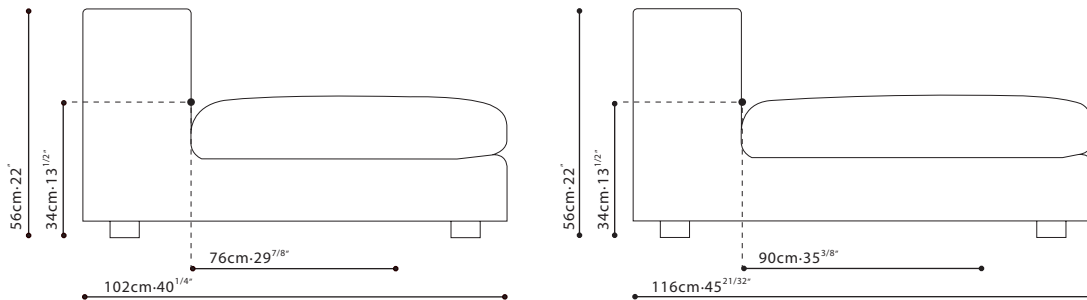

**CASA /** FRAME: Solid Birch ,covered w/fabric lined polyurethane foam. SEAT: Cross-woven elastic webbing supporting seat cushions consisting of high-resilient polyurethane foam wrapped in channeled feather down & polyester fiber. CUSHIONS: Back cushions consist of channeled feather down and polyester fiber w/a high-resilient polyurethane foam core. Feather down filled toss pillows. FEET: Inset black ABS plastic feet. UPHOLSTERY OPTIONS: Fabric (removable) or Leather (non-removable). Sofa Connectors are Included.

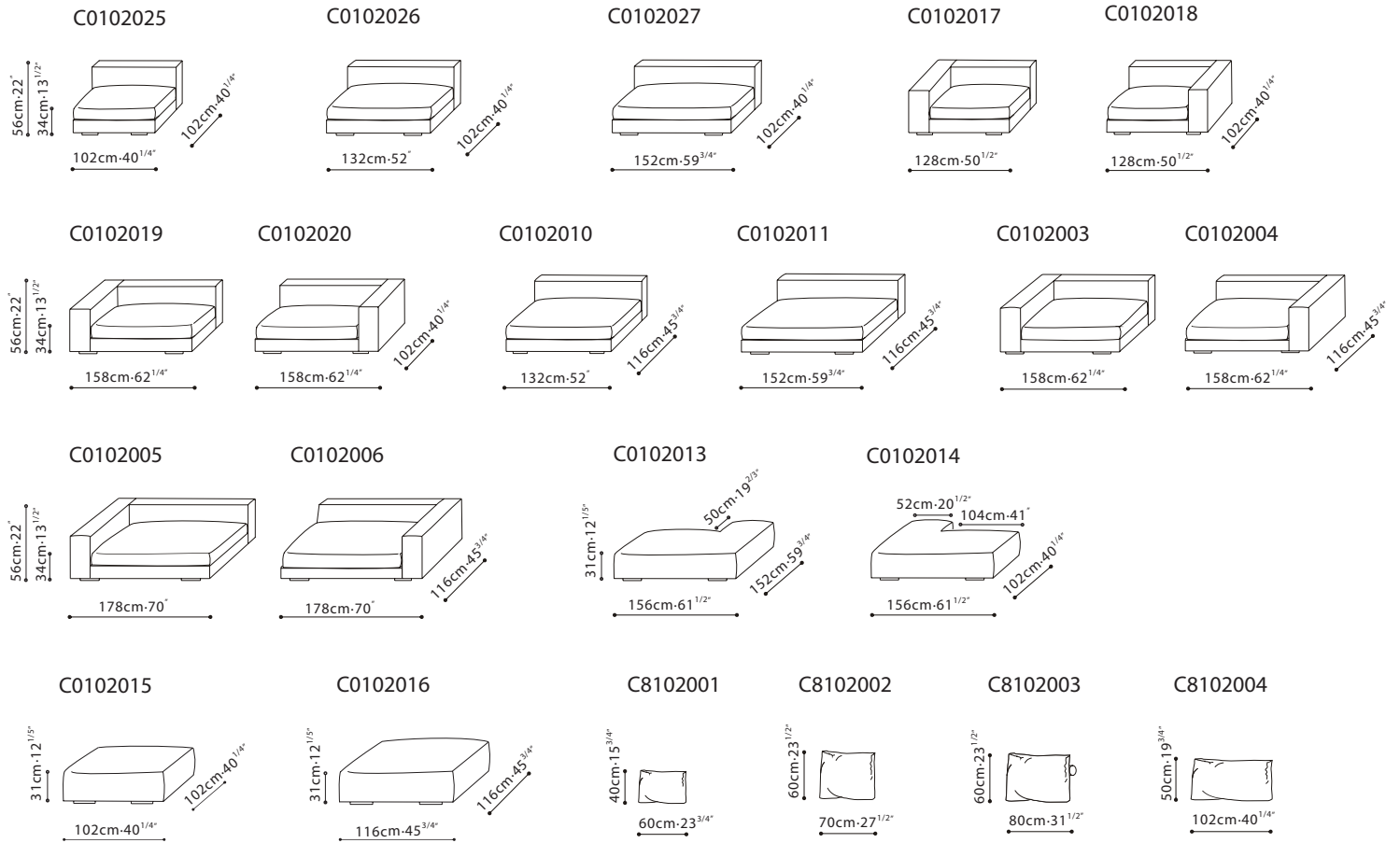

## FABRIC VERSION



## LEATHER VERSION

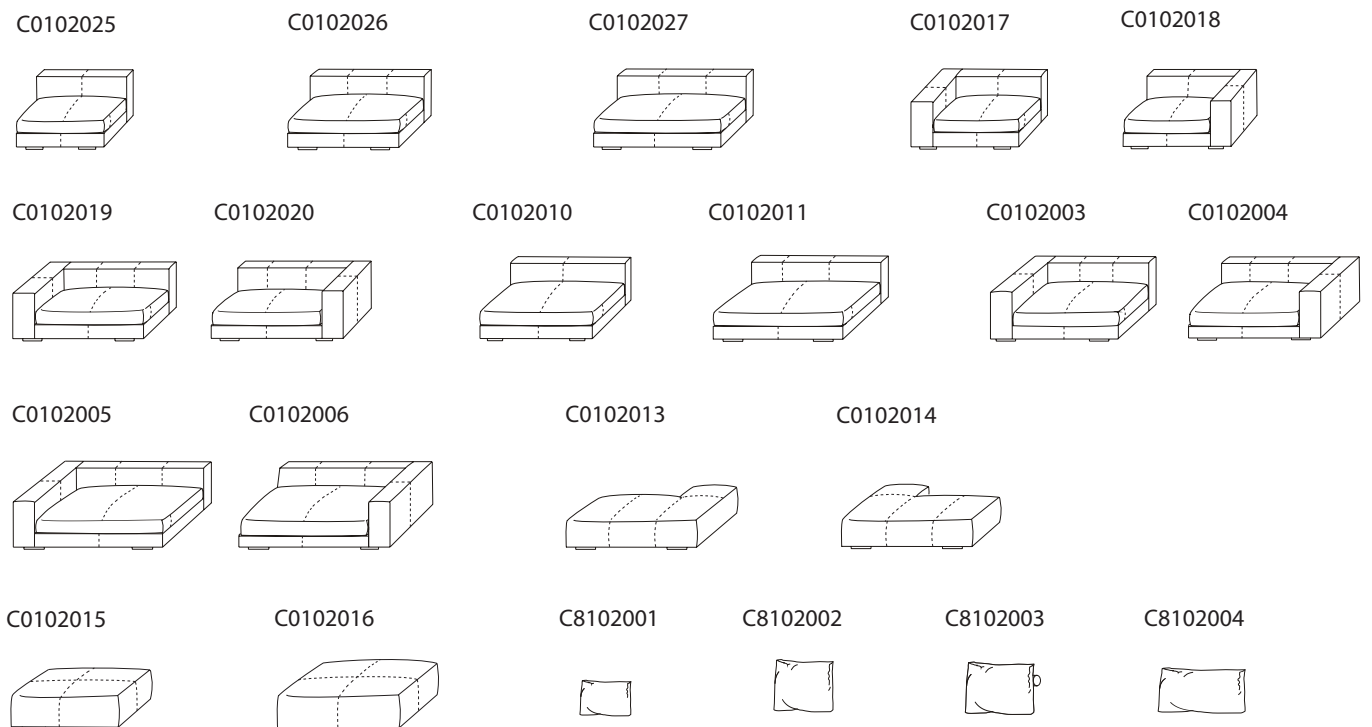

(dotted lines illustrate positioning of stitched seams on leather versions of this sofa)

## RECOMMENDED CUSHIONS

Item Code

C0102003/04	C8102001*1, and C8102002*1, and C8102003*1
C0102005/06	C8102001*1, and C8102002*1, and C8102003*1
C0102010	C8102002*1
C0102011	C8102002*1
C0102017/18	C8102004*2
C0102019/20	C8102001*1, and C8102002*1, and C8102003*1
C0102025	C8102002*1
C0102026	C8102002*1
C0102027	C8102002*1

## SAMPLE CONFIGURATION

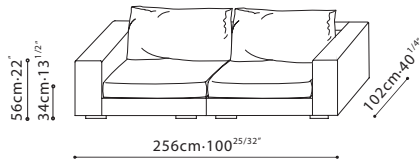

C0102017+C8102004+C0102018+C8102004

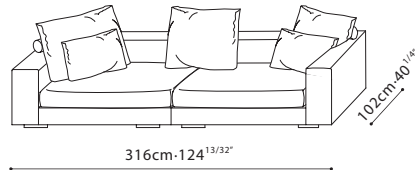

C0102019+C8102003+C8102001+C8102002+C0102020  
+C8102003+C8102001

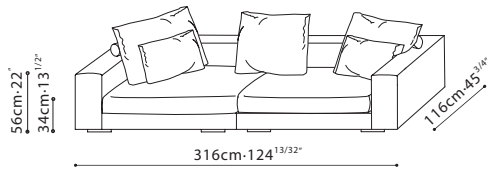

C0102003+C8102003+C8102001+C8102002  
+C0102004+C8102003

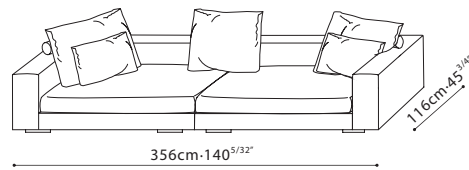

C0102005+C8102003+C8102001+C8102002  
+C0102006+C8102003+C8102001

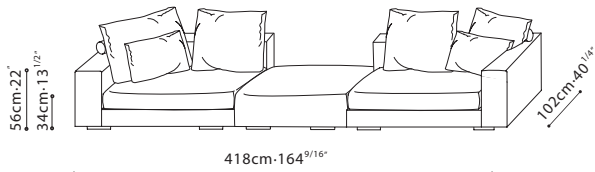

C0102019+C0102015+C0102020+C8102003x2  
+C8102001x2+C8102002x2

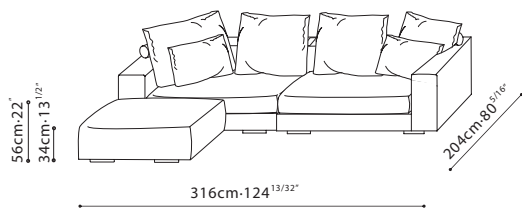

C0102019+C0102015+C0102020+C8102003x2  
+C8102001x2+C8102002x2

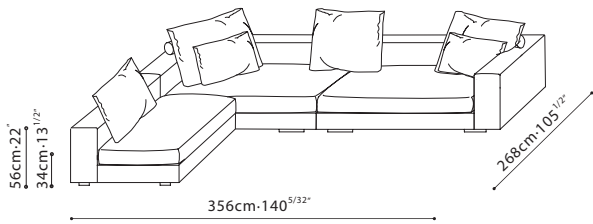

C0102011+C8102002+C0102005+C8102003+C8102001  
 +C8102002+C0102006+C8102003+C8102001

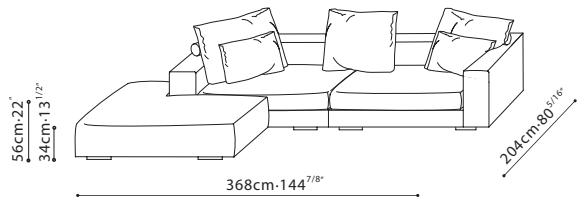

C0102014+C0102019+C8102003+C8102001+C8102002  
 +C0102020+C8102003+C8102001

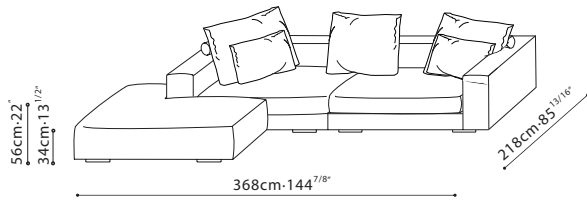

C0102014+C0102003+C8102003+C8102001+C8102002  
 +C0102004+C8102003+C8102001

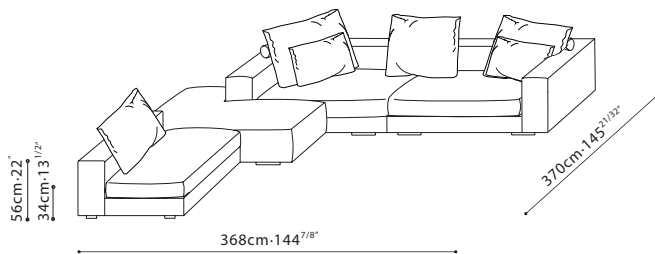

C0102027+C8102002+C0102014+C0102003+C8102003  
 +C8102001+C8102002+C0102004+C8102003+C8102001

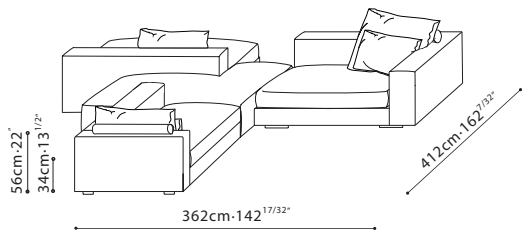

C0102027+C8102002+C0102013+C0102003+C8102003+  
 C8102001+C0102004+C8102003+C8102001