

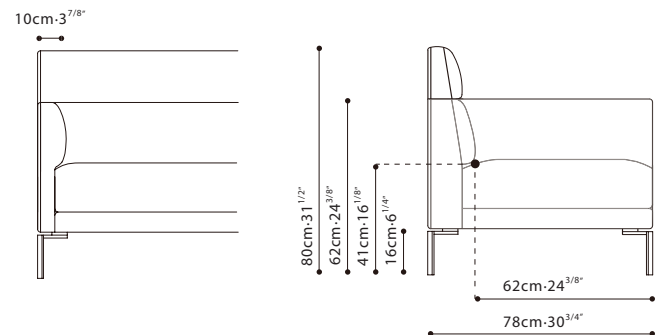

AMOR-30 / FRAME: Constructed on a solid Birch Wood frame with MDF and plywood reinforcements, paired with cross-woven elastic webbing. The Frame is covered with polyurethane foam and fabric lining. **CUSHIONS:** Seat cushions are filled with high-resilient variable-density polyurethane foam. Throw cushions are filled with feather down, and finished with hidden zippers. **LEGS:** Steel legs are finished in grey metallic paint a capped with plastic glides. **UPHOLSTERY:** Available in Fabric (removable via Velcro) or Leather (non-removable).



FABRIC VERSION

C01F0101

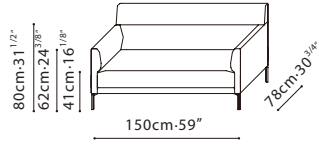

C01F0102

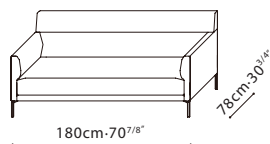

C01F0103

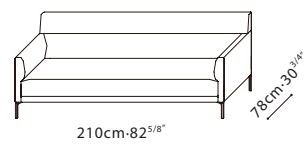

C01F0104

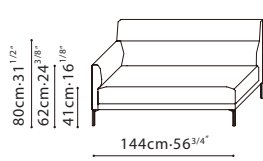

C01F0105

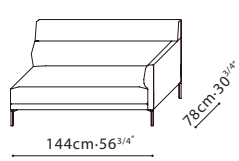

C01F0106

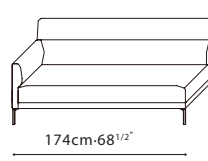

C01F0107

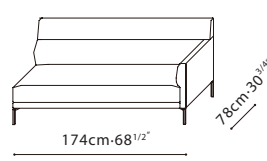

C01F0108

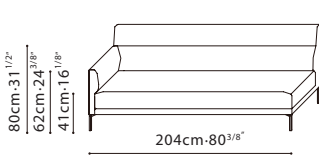

C01F0109

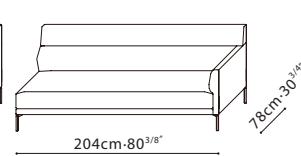

C01F0110

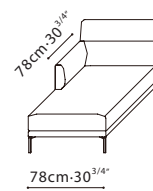

C01F0111

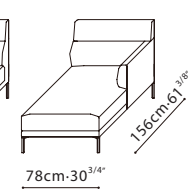

C01F0116

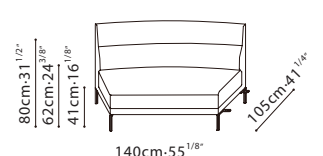

C01F0112

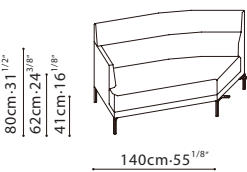

C01F0113

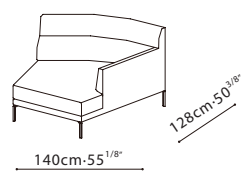

C01F0114

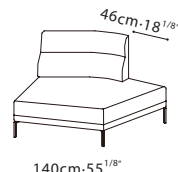

C01F0115

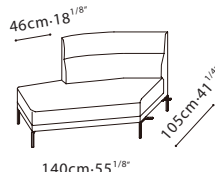

C81F0101



LEATHER VERSION

C01F0101

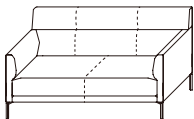

C01F0102

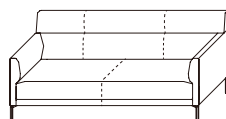

C01F0103

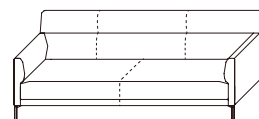

C01F0104

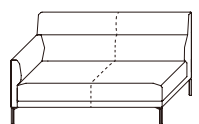

C01F0105

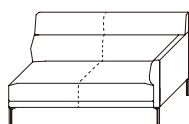

C01F0106

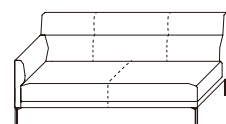

C01F0107

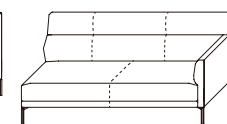

C01F0108

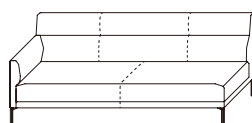

C01F0109

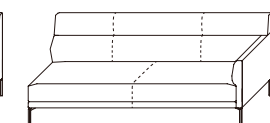

C01F0110

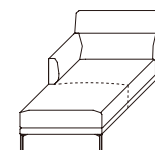

C01F0111

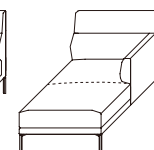

C01F0116

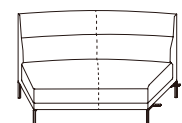

C01F0112

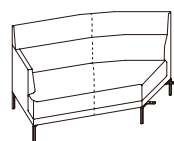

C01F0113

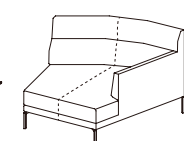

C01F0114

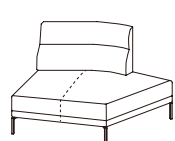

C01F0115

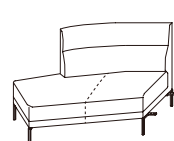

C81F0101



(dotted lines illustrate positioning of stitched seams on leather versions of this sofa)

SAMPLE CONFIGURATION

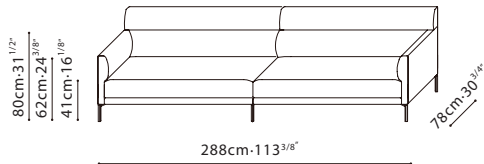

C01F0104+C01F0105

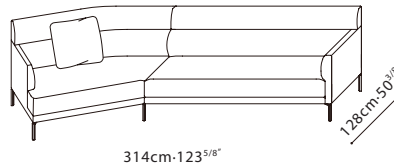

C01F0112+C01F0107+C81F0101

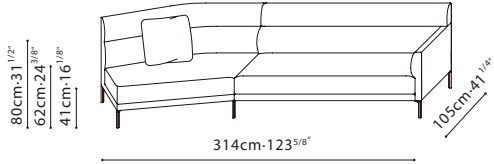

C01F0116+C01F0107+C81F0101

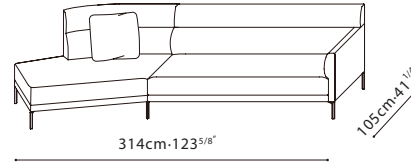

C01F0115+C01F0107+C81F0101

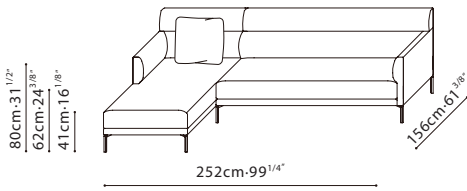

C01F0110+C01F0107+C81F0101

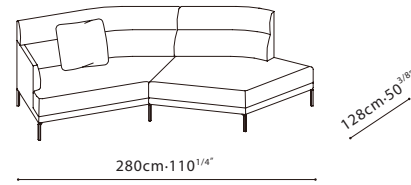

C01F0112+C01F0114+C81F0101

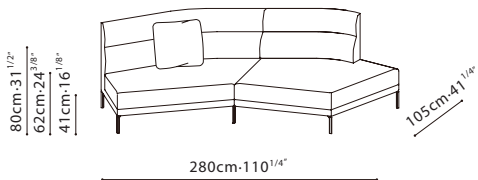

C01F0116+C01F0114+C81F0101

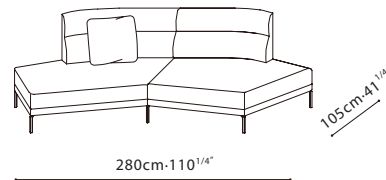

C01F0115+C01F0114+C81F0101

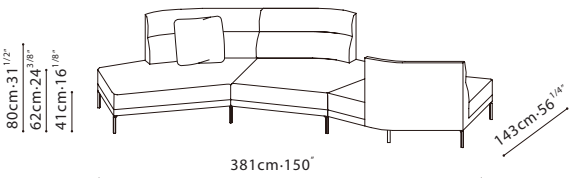

C01F0115+C01F0114x2+C81F0101

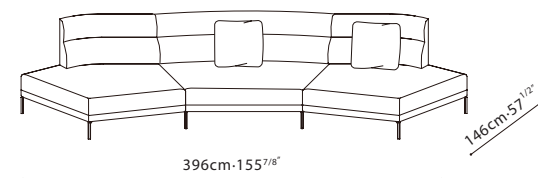

C01F0115+C01F0116+C01F0114+C81F0101x2

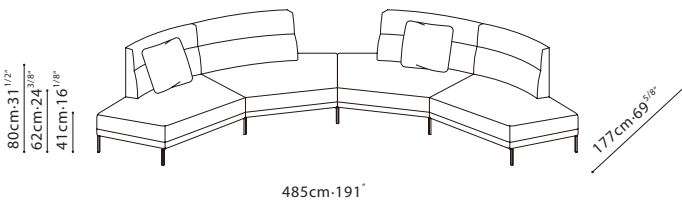

C01F0115+C01F0114+C01F0115+C01F0114+C81F0101x2